



Division of
Wm. K. Walthers, Inc.

ACCESSORY VALUE PACK

START HERE

All of these Darda pieces are included in your value pack!
Check to be sure you have them all.

1. Unpack the parts. Save all packing material.
2. Check off the parts in the spaces below. **NOTE: Some sections may be connected in packaging. Be sure to separate track pieces so you can account for all parts.**
3. Look in the carton again and sort through all of the packing material to make sure you didn't miss any parts.
4. Use the adjustment form on this sheet to order any missing parts.



WARNING:

CHOKING HAZARD - Small parts

Not for children under 3 years

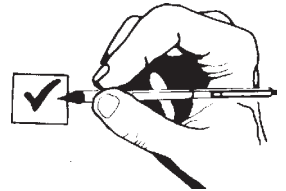

PARTS LIST

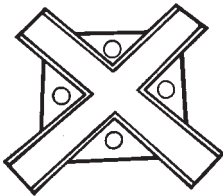

1 90° CROSS TRACK

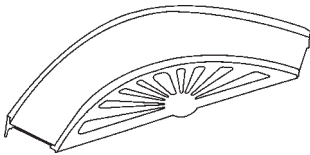

3 90° CURVES

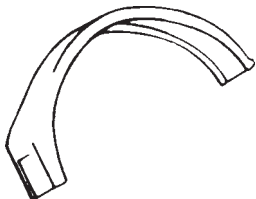

4 LOOP HALVES

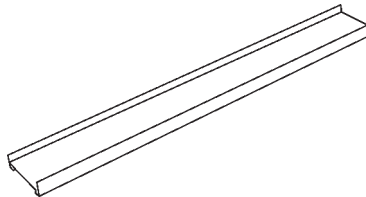

4 7" STRAIGHT TRACKS

2 14" STRAIGHT TRACKS

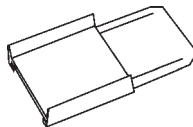

1 1.75" STRAIGHT TRACK

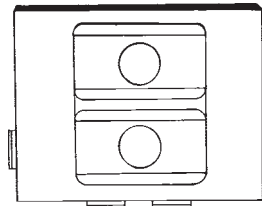

1 SMALL BASE PLATE

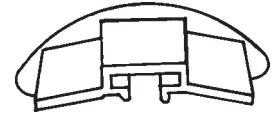

4 LOOP JOINERS

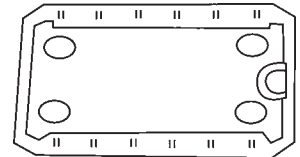

11 TRACK JOINERS

If a part is missing or damaged:
The store where you purchased this item does not have parts. You will get the easiest service from Wm. K. Walthers. Tell us the part or parts needed and be sure to include your name and address printed clearly. Mail to address on last page.

ILLUSTRATIONS SHOWN IN THESE INSTRUCTIONS MAY NOT ACCURATELY DEPICT ITEMS IN THIS SET.



The instructions on the following two pages explain how to use each individual piece contained in your Accessory Value Pack. Use these instructions, your current collection of Darda pieces, and your imagination to create your very own exciting track layouts and challenging stunts.

You can also use the pieces contained in your Accessory Value Pack to make the mini track layout shown on the following page. Instructions on how to add these pieces into an existing Darda set, containing a 180° curve, are pictured on page 4.

READ ALL INSTRUCTIONS BEFORE YOU BUILD YOUR TRACK LAYOUT!!!

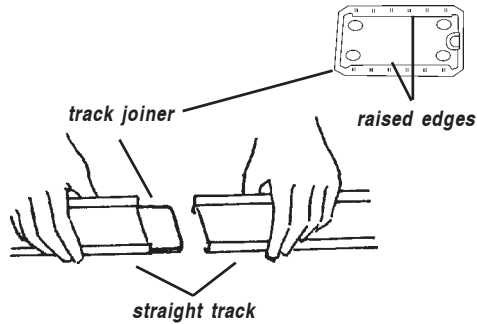

USING JOINERS

Track joiners are used to connect straight tracks, curves, and cross tracks. With raised edges of the joiner face down, slide the track piece over half of the joiner. Leave room for another piece of track to cover the part of the joiner that is left showing. After you join the track together be sure there are no gaps.

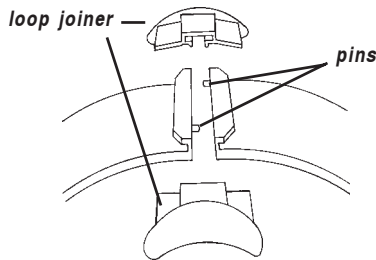

Loop joiners are used to secure the tops of two halves to form a loop.

Put two loop halves together so that the pins go into the proper holes creating a seam between the two loop halves. Holding the loop halves together, slide one loop joiner over one end of the seam and the other loop joiner over the other end of the seam.

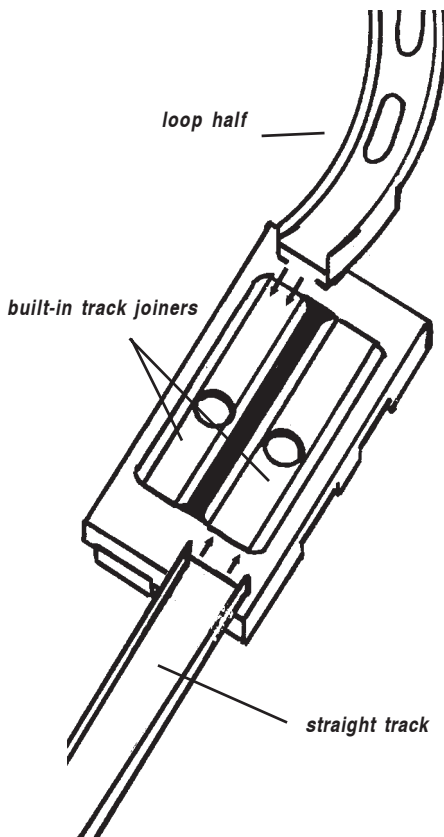

USING THE SMALL BASE PLATE

Small base plates are used to secure straight tracks and the bottom part of loop halves when creating loops in track layouts.

Straight tracks attach to the small base plate by sliding them half way over the built-in track joiner. The other half of the built in track joiner is now ready for loop half attachment

The **loop half** is attached by sliding the bottom portion over the built-in track joiner. The other half of the built-in joiner is now ready for straight track attachment.

To complete the loop, slide the second loop half over half of the empty built-in track joiner located next to the straight track. Now attach a second straight track to cover the remaining half of the built-in joiner. (A complete loop is pictured in the next section.)

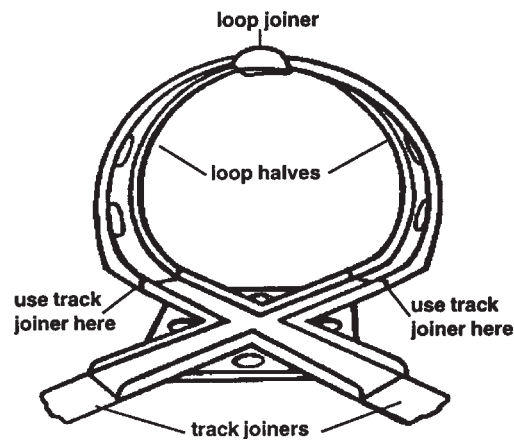

USING THE 90° CROSS TRACK

The **cross track** is used with loop halves and straight track to form an intersection.

Loop halves and straight tracks are attached to the cross track using track joiners. Refer to the USING JOINERS section of these instructions for further detail.

MINI TRACK LAYOUT

All the pieces you need to put together this track layout are in your Accessory Value Pack! Use the eleven track joiners to connect straight track, curves and cross track.

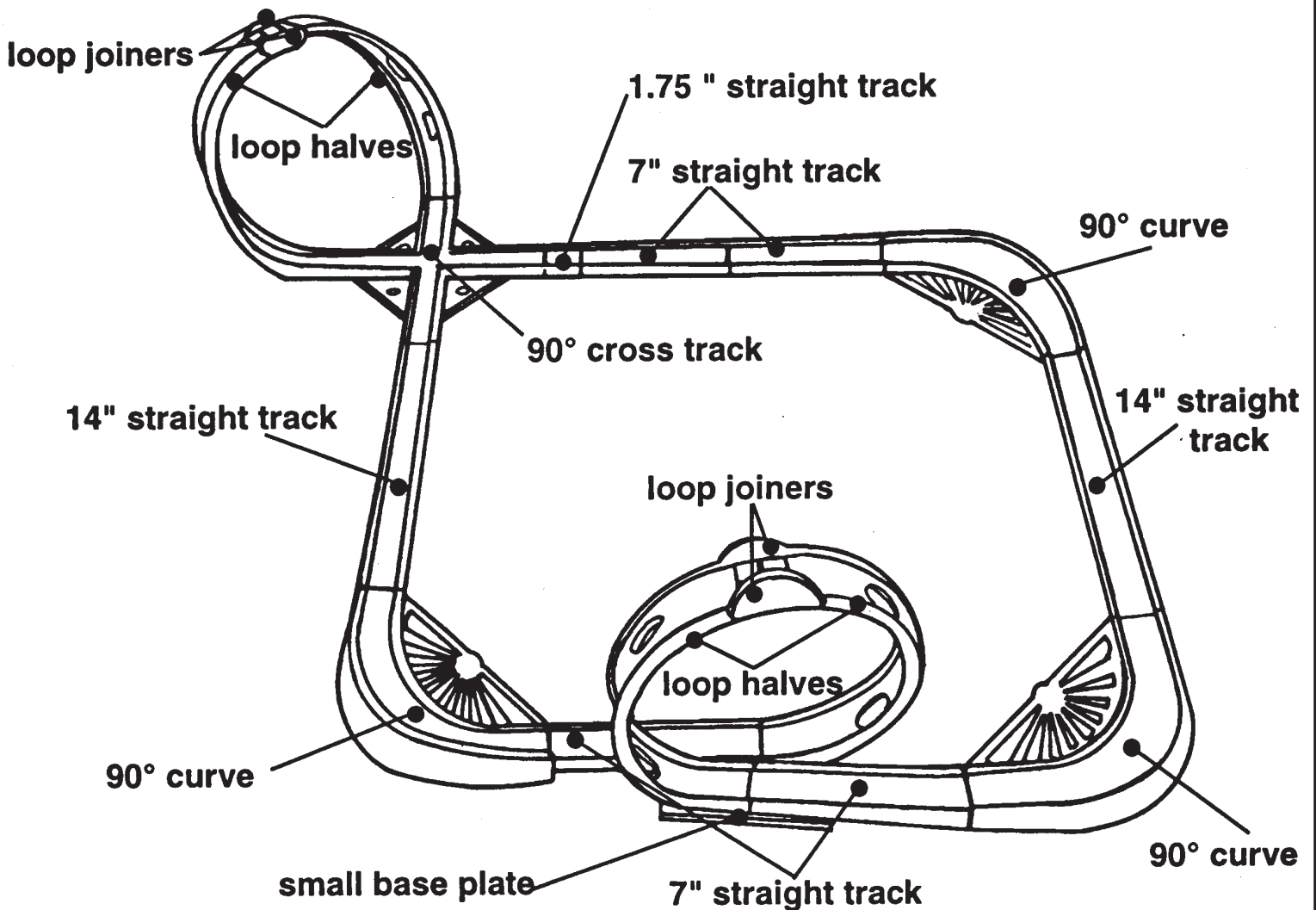

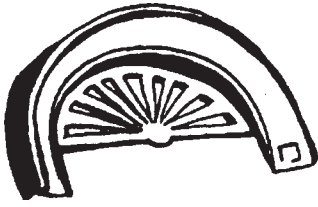

180° Curve
NOT INCLUDED IN
YOUR ACCESSORY
VALUE PACK

ADDING TO EXISTING DARDA SETS

Here's one way to add all the pieces in this Accessory Value Pack to any set containing a 180° curve.

Assemble the layout below using the pieces in your Accessory Value Pack. Remove the 180° curve from your existing DARDA set layout. Attach this curve as shown below. The open end of the track configuration (7" straight track and 90° curve) will connect to your existing DARDA set layout in place of the 180° curve.

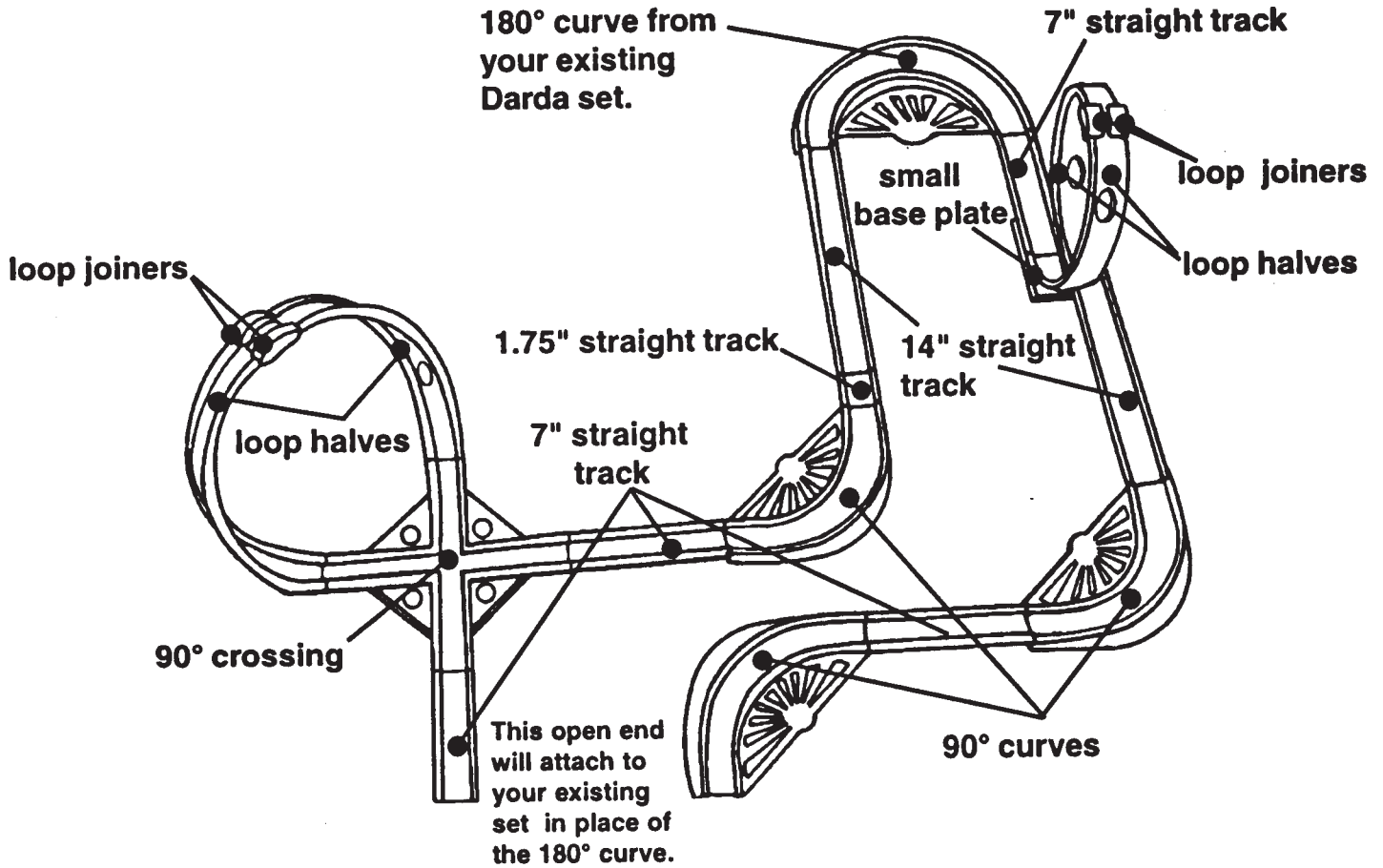

NOTE: Depending on which set(s) or car(s) you already have, one car may not be able to complete a full circuit around your expanded track layout. This is a great opportunity to race several cars on the track. Try starting them in different locations to see how far they can go! Witness awesome bump 'n' go action by setting up cars with special stop 'n' go motors at various points around the track. Wind the first car up and let it go crashing into the second car that will take off and crash into another waiting car. After you have mastered this track configuration, build another of your very own. The fun never ends!

QUESTIONS??

Call Darda's Toll-Free Consumer Helpline at:
1-800-773-9350

SERVICE DEPARTMENT HOURS:
9:00 AM — 3:30 PM (Central Time) MONDAY — FRIDAY

Wm. K. Walthers, Inc. 5601 W. Florist Ave. • Milwaukee, WI 53218 • www.walthers.com